

Height Measuring Instrument Digimar 817 CLM



- Top or bottom contacting
- Web width or distances between grooves, including center of web or groove
- Bore or shaft diameter, including center of bore or shaft
- Bore reversing point (up or down)
- Shaft reversing point (up or down)
- Calculating distances or symmetry
- Dynamic measuring functions
- Perpendicularity measurement
- Straightness measurement
- Measurement in 2D mode
- Measuring programs
- Statistical evaluation
- Measuring data processing
- Large and clearly defined function keys
- Easy to read background lit graphic LCD-Display
- Operator guidance with self-explanatory icons / pictograms
- Operator prompts and menus are available in several languages
- Possible to set additional zero points on a work piece
- Additional measurement instruments with Opto RS232-interface can be connected
- Secure the future due to software update potential
- Automatic Stand-by switch mode
- Selectable Auto-off function, without loss of measured values
- Excellent accuracy and reliability due to the optical incremental measurement system with the double reader head
- Dynamic probing system enabling high repeatability
- Air bearings system for light and smooth movement
- Precise measuring head on stainless steel guideways
- Motorized measuring carriage simplifies measurement runs
- Probe constant remains after the instrument is switched off
- Integrated rechargeable battery with a long operating time span for power source independent measurement
- Temperature compensation with an integrated temperature sensor
- **Software:** MarCom Professional free download: www.mahr.com/marcom (only for Mahr data cables and wireless systems with USB and RS232 interface)
- **Scope of delivery:** Height Measuring Instrument incl. Operating and display unit, Carrier 817h1, Probe K6/51, Setting block 817 eb, Instruction manual, Power source, USB cable, Protection cover, Calibration certificate

Technical Data

Order no.		4429010	4429011	4429012
Product type			817 CLM	
Measuring range	mm	0 – 350	0 – 600	0 – 1000
Measuring range	inch	0 – 14"	0 – 24"	0 – 40"
Application range from	mm		170	
Application range to	mm	520	770	1170
Resolution	mm	0,01, 0,005, 0,001, 0,0005, 0,0001		
Resolution	inch	.001", .0005", .0001", .00005", .00001"		
Error limit	µm	(1.8+L/600) L in mm		
Repeatability bores	µm	1		
Repeatability plane	µm	0,5		
Perpendicularity error	µm	5	6	10
Operation time max.	h	10		
Measuring force	N	1.0 +/-0.2 N		
Relative humidity non-condensing	%	65		
Working temperature	°C / °F	20 / 68		
Operating temperature	°C / °F	10 –40 / 50–104		
Product weight	kg / lbs	25,00 / 55.15	30,00 / 66.14	35,00 / 77.16
Data interface		USB, RS232C, Wireless		
Standard		Factory standard		

Accessories

Order no.	Product description	Product type
7024634	Data Connection Cable RS232C (3 m)	
4102333	Adapter Cable RS232-USB (1 m)	817 usb
4102233	Transmitter for e-Stick	RS232 e
4102230	Receiver	e-Stick
4221525	Surface Plate made from granite, 1000 x 630 mm	107 G
4221573	Stand, 1000 x 630 mm	107 Ug
4221526	Surface Plate made from granite, 1200 x 800 mm	107 G
4221574	Stand, 1200 x 800 mm	107 Ug



e-Stick



107 Ug

Height Measuring Instrument Digimar 816 CL



Basic measuring functions

- Top or bottom contacting
- Web width or distances between grooves, including center of web or groove
- Bore or shaft diameter, including center of bore or shaft
- Bore reversing point (up or down)
- Shaft reversing point (up or down)
- Calculating distances or symmetry
- Dynamic measuring functions
- Measuring program
- Measuring data processing
- Easy to read background lit graphic LCD-Display
- Large and clearly defined function keys
- Operator guidance with self-explanatory icons / pictograms
- Possible to set additional zero points on a work piece
- Memory can store up to 99 measured values
- MarConnect Data output, select either:
 - USB
 - OPTO RS232C
- Excellent accuracy and reliability due to the optical incremental measurement system with the double reader head
- Dynamic probing system enabling high repeatability
- Air bearings system for light and smooth movement
- Precise measuring head on stainless steel guideways
- Motorised measuring carriage simplifies measurement runs
- Temperature compensation with an integrated temperature sensor
- Probe constant remains after the instrument is switched off
- Integrated rechargeable battery with a long operating time span for mains independent measurement
- **Software:** MarCom Professional free download:
www.mahr.com/marcom (only for Mahr data cables and wireless systems with USB and RS232 interface)
- **Scope of delivery:** Height Measuring Instrument incl. Operating and display unit, Carrier 817h1, Probe K6/51, Setting block 817 eb, Instruction manual, Power source, Protection cover, Calibration certificate



Technical Data

Order no.		4429030	4429031
Product type		816 CL	
Measuring range	mm	0 - 350	0 - 600
Measuring range	inch	0 - 14"	0 - 24"
Application range from	mm	170	
Application range to	mm	520	770
Resolution	mm	0,01, 0,001	
Resolution	inch	.00005", .0001"	
Error limit	µm	(2.8+L/300) L in mm	
Repeatability bores	µm	3	
Repeatability plane	µm	2	
Perpendicularity error	µm	15	20
Operation time max.	h	10	
Measuring force	N	1.0 +/- 0.2 N	
Relative humidity non-condensing	%	65	
Working temperature	°C / °F	20 / 68	
Operating temperature	°C / °F	10 - 40 / 50 - 104	
Product weight	kg / lbs	25.00 / 55.15	30.00 / 66.14
Data interface		Opto RS232C, USB, Wireless	
Standard		Factory standard	

Accessories

Order no.	Product description	Product type
4346023	Data connection cable USB (2 m)	2000 usb
4346020	Data Connection Cable RS232C (2 m)	2000 r
4102232	Transmitter for e-Stick	2000 e
4102230	Receiver	e-Stick
4221526	Surface Plate made from granite, 1200 x 800 mm	107 G
4221574	Stand, 1200 x 800 mm	107 Ug
4221525	Surface Plate made from granite, 1000 x 630 mm	107 G
4221573	Stand, 1000 x 630 mm	107 Ug



e-Stick



107 Ug

Probe set Digimar 817 ts 1

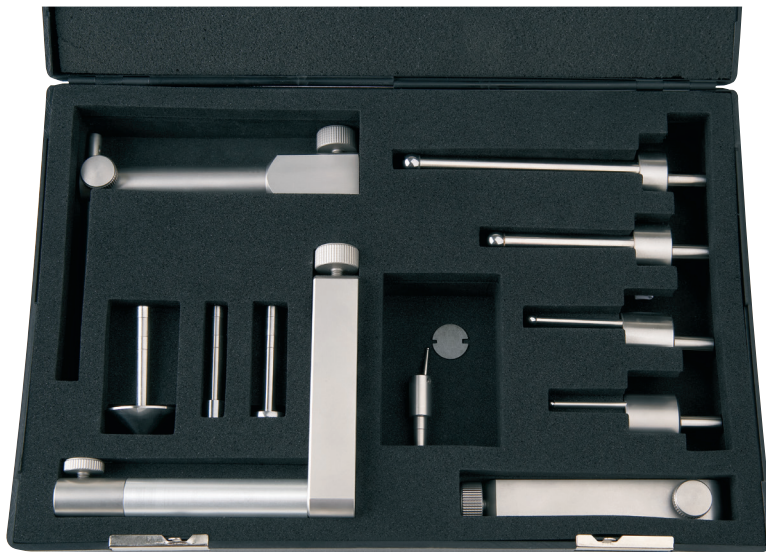

- Large accessory kit
- Packaged in a practical plastic case
- Consisting of:
 - Depth probe
 - Carrier with extended holder
 - Disc measuring probe for grooves, etc.
 - Conical measuring probe
 - Cylindrical measuring probe
 - Holder for test indicator styli with M2 thread
 - Carrier including 4 spherical probes with shaft diameter 8 mm
- **Scope of delivery:** Case

Technical Data

Order no.	Product type
4429019	817 ts 1

Components included in set

Order no.	Product description	Product type
4429219	Carrier for a probe, Mounting hole 6 mm, a = 100,5 mm, b = 119,5 mm, c = 84 mm	817 h2
4429226	Disc probe \varnothing 15 mm	S15/31,2
4429227	Cylindrical probe \varnothing 10 mm	Z10/31,2
4429228	Taper probe	MKe 30
4429221	Depth probe incl. carrier	TMT 120
4429256	Probe M2 incl. styli 800 ts \varnothing 2,0 mm	KM 2
4429220	Carrier for probes 817 CLM, Mounting hole 8 mm	817 h4
7023813	Probe with mount, \varnothing 4,0 mm	K 4/30
7023816	Probes with mount, \varnothing 6 mm	K 6/40
7023810	Probes with mount, \varnothing 10,0 mm	K 10/60
7023615	Probes with mount, \varnothing 10,0 mm	K 10/100

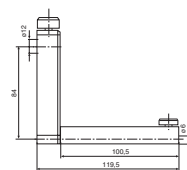

817 h2

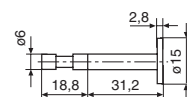

S15/31,2

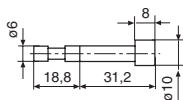

Z10/31,2

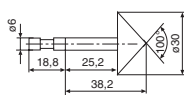

MKe 30

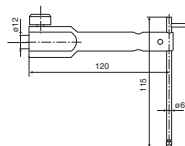

TMT 120

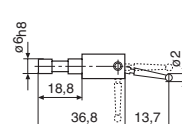

KM 2

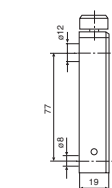

817 h4

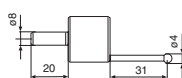

K 4/30

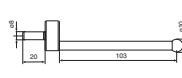

K 10/100



K 6/40

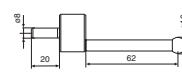

K 10/60

Probe set Digimar 817 ts2

- Small accessory kit
- Packaged in a practical plastic case
- Consisting of:
 - Depth probe
 - Carrier with extended holder
 - Disc measuring probe for grooves, etc.
 - Conical measuring probe
 - Cylindrical measuring probe
 - Holder for test indicator styli with M2 thread
- **Scope of delivery:** Case

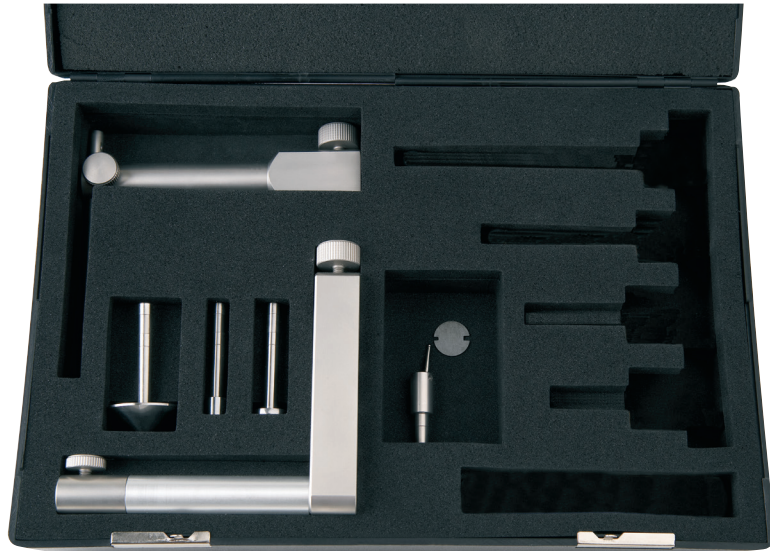

Technical Data

Order no.	Product type
4429018	817 ts2

Components included in set

Order no.	Product description	Product type
4429219	Carrier for a probe, Mounting hole 6 mm, a = 100,5 mm, b = 119,5 mm, c = 84 mm	817 h2
4429226	Disc probe \varnothing 15 mm	S15/31,2
4429227	Cylindrical probe \varnothing 10 mm	Z10/31,2
4429228	Taper probe	MKe 30
4429221	Depth probe incl. carrier	TMT 120
4429256	Probe M2 incl. styli 800 ts \varnothing 2,0 mm	KM 2

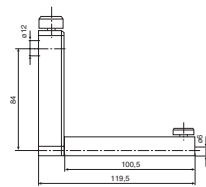

817 h2

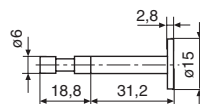

S15/31,2

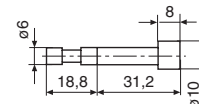

Z10/31,2

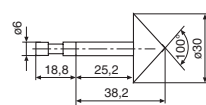

MKe 30

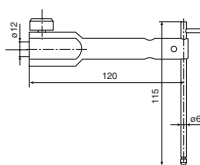

TMT 120

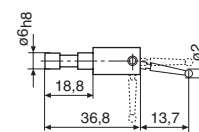

KM 2

Height Measuring and Scribing Instrument Digimar 814 SR

REFERENCE



Functions:

- RESET (set display to zero)
- mm/inch
- ABS (Switch between Relative and Absolute measurement)
- Lock/Unlock
- PRESET (for entering a numerical value)
- DATA (Data transmission via connection cable)
- AUTO-ON / OFF

- Battery life up to 3 years
- Max. measuring speed 1,5 m/s (60"/s)
- MarConnect Data output: choose either
 - USB
 - OPTO RS232C
 - Digimatic
- High contrast Liquid Crystal Display with 12 mm sized digits
- Sturdy heavy-duty base, easy to handle
- Hardened and lapped contact surface which produce both a smooth and even movement
- Slide and beam made of hardened stainless steel
- Hand crank for positioning and measuring
- Fine adjustment
- Locking screw
- Interchangeable scriber point, carbide tipped
- **Software:** MarCom Professional free download:
www.mahr.com/marcom
 (only for Mahr data cables and wireless systems with USB and RS232 interface)
- **Scope of delivery:** Scriber, Battery, Carton, Instruction manual

Application:

- Scribing and marking of work pieces
- Measuring Heights and distances



Technical Data

Order no.		4426100	4426101
Product type		814 SR	
Measuring range	mm	0 - 350	0 - 600
Measuring range	inch	0 - 14"	0 - 24"
Resolution	mm	0,01	
Resolution	inch	.0005"	
Error limit	µm	40	50
Operation time max.	h	4000	
Operating temperature	°C / °F	10 - 40 / 50 - 104	
Product weight	kg / lbs	7.00 / 15.43	8.00 / 17.64
Data interface:		Opto RS232C, Digimatic, USB, Wireless	
Standard		Factory standard	

Order no.	a	b	c	d
	mm	mm	mm	mm
4426100	62	180	35	580
4426101	62	180	35	835

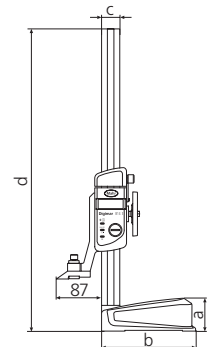

Accessories

Order no.	Product description	Product type
4123867	Measuring/Scriber Point, carbide tipped	814 SRs
4123041	Holder for test indicators	27 Sp
4102357	Data Connection Cable USB (2 m)	16 EXu
4102915	Digimatic data cable (2 m)	16 EWd
4102410	Data Connection Cable RS232C (2 m)	16 EXr
4102230	Receiver	e-Stick
4102231	Transmitter for e-Stick	16 EWe
4102520	Battery 3 V, CR 2032	

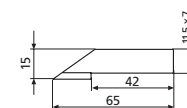

814 SRs;

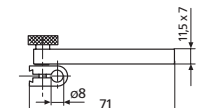

27 Sp



e-Stick



16 EWe